

500 GALLON HAZARDOUS CHEMICAL AND FUEL CONTAINMENT VESSEL

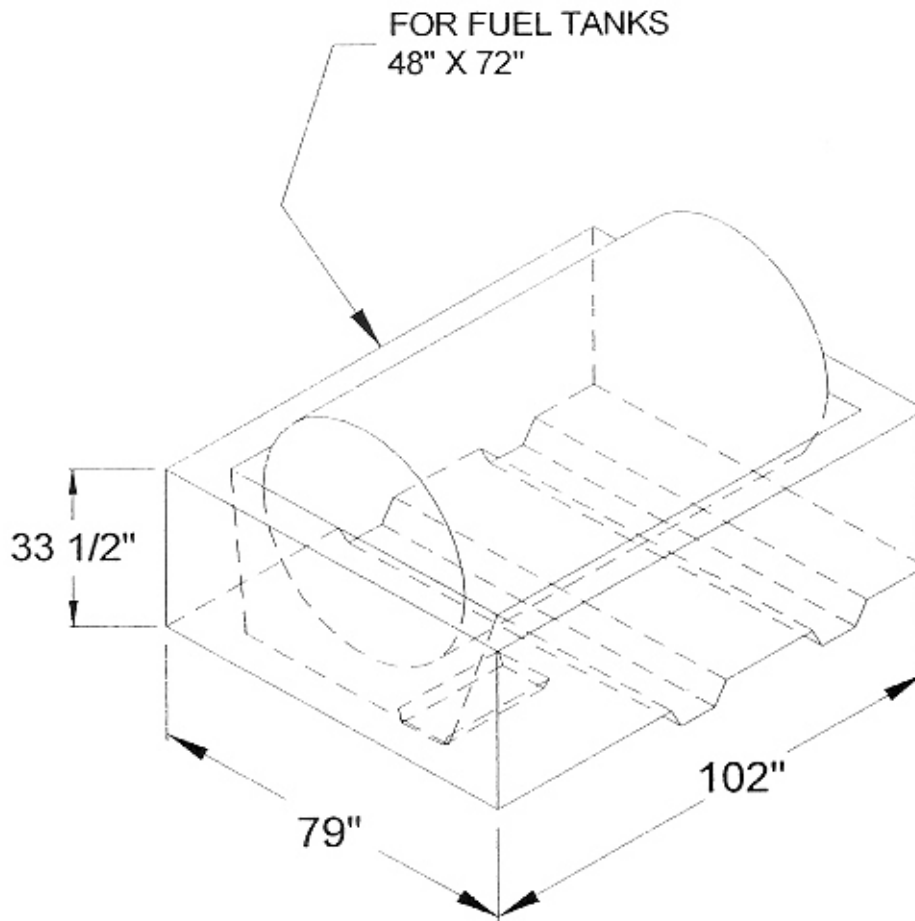

SHEET 1 OF 2

GROVE CONCRETE & SUPPLY, INC.
18426 DURAND AVENUE P.O. BOX 363
UNION GROVE, WISCONSIN 53182
(262) 878-2030

500 GALLON TANK
CONTAINMENT VESSEL

DRAWN: Dx DATE: 01/04/02

SCALE: NTS

DWG. NUMBER: CON-500

THIS DRAWING AND THE INFORMATION CONTAINED HEREON IS THE EXCLUSIVE PROPERTY OF GROVE CONCRETE & SUPPLY, INC., AND SHALL NOT BE REPRODUCED, USED, OR DISCLOSED TO OTHERS EXCEPT AS AUTHORIZED THROUGH WRITTEN CONCENT FROM GROVE CONCRETE & SUPPLY, INC.